



ENGINEERED CLASS SPROCKETS

PRODUCT	PAGE
INDEX	F-1
MADE-TO-ORDER CAPABILITIES	F-3
INSTANT SPLIT® SPROCKETS	F-5
SOLID AND SPLIT DETACHABLE HUBS	F-6
SHEAR PIN SPROCKETS	F-7– F-9
ACCU-TORCH® SPROCKETS	F-10 – F-15
1.654 PITCH (62)	F-11
2.609 PITCH (78)	F-11
3.067 PITCH (1568)	F-12
3.075 PITCH (1030)	F-12
3.075 PITCH (82)	F-13
3.500 PITCH (238)	F-13
4.000 PITCH (124)	F-14
4.063 PITCH (1240)	F-14
4.500 PITCH (635)	F-15
5.000 PITCH (1207)	F-15
6.050 PITCH (132)	F-15
81X HOOKED TOOTH	F-16
Star Gear	F-16
WARNING & SAFETY REMINDER	Opposite Page

ENGINEERED

Steel Accu-Torch® Sprockets for Engineering Chains

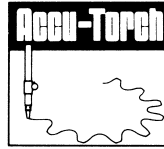

Martin

Accu-Torch

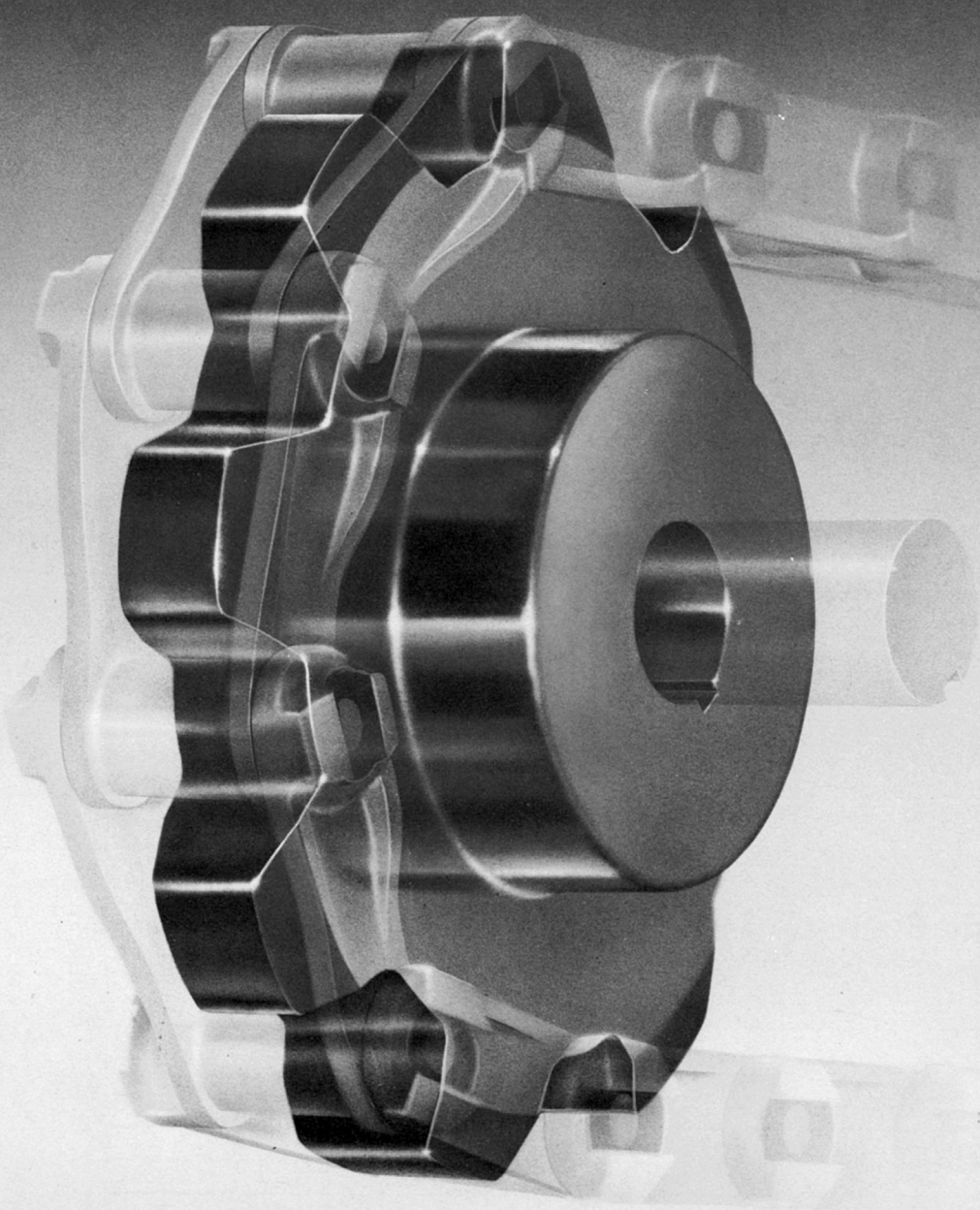
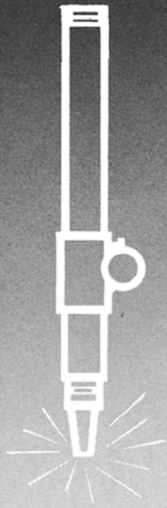

ENGINEERED

Special Engineered Class Sprockets



SPECIAL SPLIT ACCU-TORCH®



**SPLINED MUD RELIEF
ACCU-TORCH®**



**SPECIAL ACCU-TORCH®
FOR SEWAGE TREATMENT**



**10 FT. DIAMETER ACCU-TORCH®
FOR PAPER MILLS**

For quality and dependable service, call *Martin* for all your made-to-order requirements.

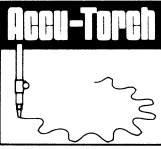

Steel Sprockets

Martin

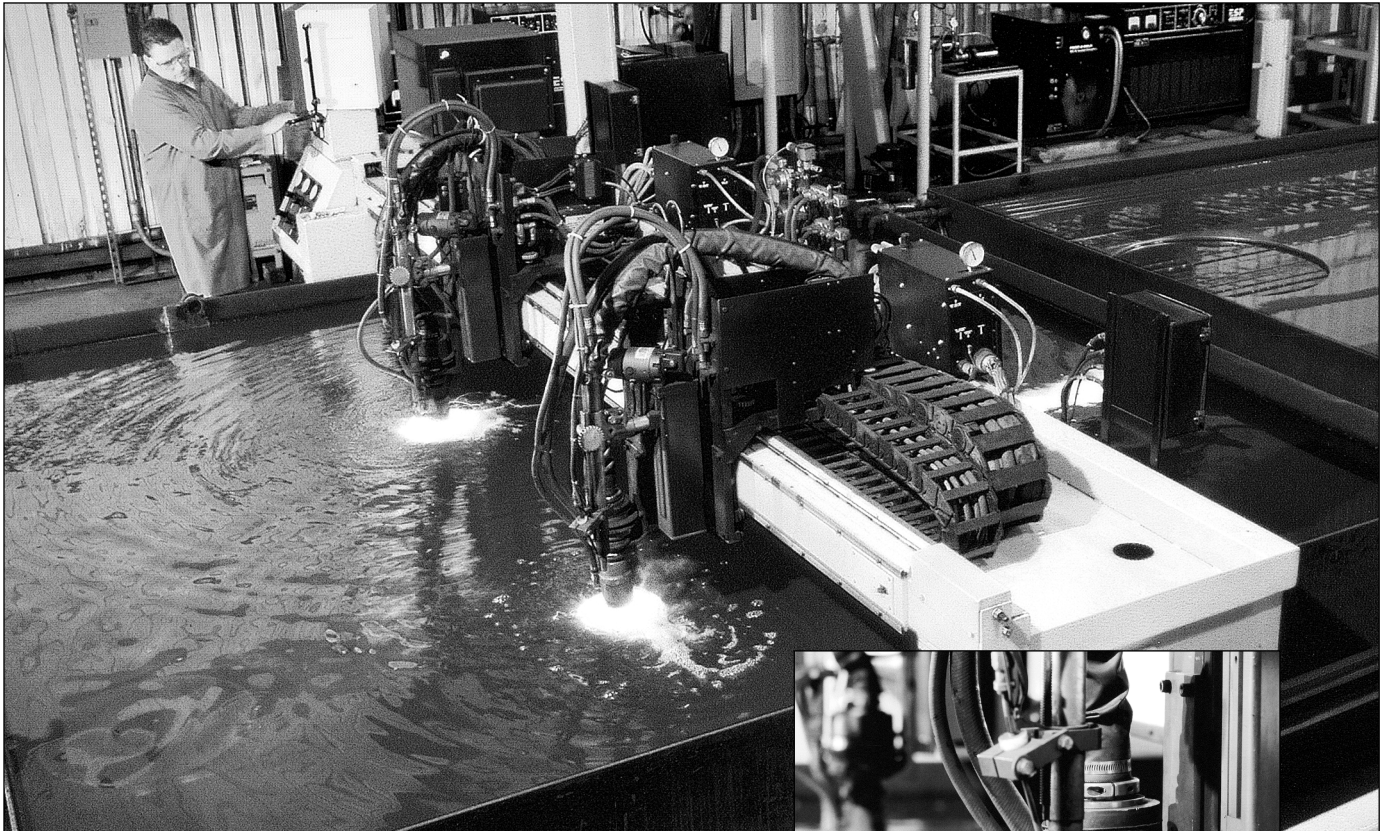

ENGINEERED



Martin Accu-Torch® steel sprockets are available for virtually all engineering class chains in style A, B, and C. Also available as split with welded hub and split or solid detachable hub. May also be furnished as shear pin type. Send us your inquiries.

Where possible please specify chain number, pitch diameter, number of teeth, bore and keyway size, and hub style required.

Accu-Torch® sprockets are not intended to replace cut tooth roller chain sprockets.

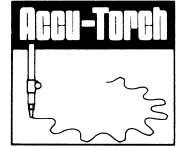

Martin Instant Split®/Accu-Torch® sprockets offer unlimited design and are simply installed with a hand wrench... greatly reducing costly downtime.

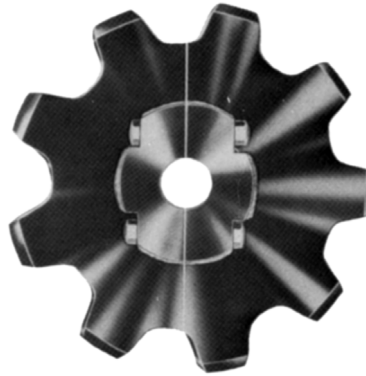

Accu-Torch® Size for Instant Split® Hubs

Split Hub Number	Bore	Minimum Number of Teeth										
		Chain Number/Pitch										
		62 1.654	78 2.609	1568 3.067	1030 3.075	82 3.075	238 3.500	124 4.000	1240 4.063	635 4.500	1207 5.000	132 6.050
S-1	¾"-1½"	9	7									
S-2	1½"-2¼"	12	8	8	8	7	8	6	7			
S-3	2"-3"	15	10	10	9	9	9	7	8	8		
S-4	2¾"-4"	18	12	12	11	11	10	9	9	9	8	
S-5	3¾"-5"	21	14	13	13	12	12	10	10	10	9	7
S-6	4¾"-6"	23	15	14	14	13	13	11	11	11	10	8
S-7	5¾"-7"	27	18	16	16	15	15	12	13	12	11	9
S-8	6¾"-8"	31	20	18	18	17	16	14	14	14	13	10

Total list price of *Martin* Split-Sprocket is simply the hub price plus the plate price.

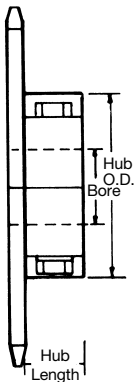

Pricing Example Style B
1030B25 Split with S-3 Hub,
2½" Bore, KW & SS

S-3 Hub
1030A25 Plate

See Hub List
See Plate List
Total Price List

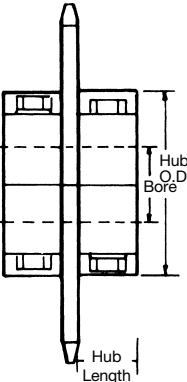

Pricing Example Style C
1030G25 Split with S-3 Hubs,
2½" Bore, KW & SS

Two S-3 Hubs
1030A25 Plate

See Hub List
See Plate List
Total Price List

Instant Split Hubs are for use
with Plate Sprockets only.

Hub Number	Bore	Hub O.D.	Hub★ Length	Bolts	Weight Lbs.
S-1	¾"-1½"	3¾"	1"	¾" x 2¼"	1.8
S-2	1½"-2¼"	4¾"	1¼"	½" x 3"	4.1
S-3	2"-3"	6"	1½"	¾" x 4½"	8.4
S-4	2¾"-4"	7¾"	1¾"	¾" x 5½"	14.4
S-5	3¾"-5"	9¾"	2"	1" x 6"	27.8
S-6	4¾"-6"	10¾"	2¼"	1" x 6"	35.4
S-7	5¾"-7"	12½"	2½"	1" x 7"	64.4
S-8	6¾"-8"	14¾"	3"	1" x 8"	98.5

★Add hub length to plate thickness to determine length thru bore.

For style C, add hub length X 2.

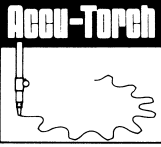

Solid and Split Detachable Hubs



TYPE D SPROCKETS — STOCK DETACHABLE HUBS

Type D sprockets consist of a Type A plate sprocket bolted to a detachable hub. A solid or split plate sprocket may be assembled to a solid or split hub. When ordering a Type D sprocket, be sure to select a plate sprocket large enough to allow chain clearance over the hub flange diameter, dimension D.

Bolt holes of Type D hubs are drilled for interchangeability. Speed ratios may be changed simply by removing the plate sprocket and substituting another with a different number of teeth. When worn, the sprocket may be reversed to use the unworn tooth surfaces, increasing the life of the sprocket.

Solid Hubs - Steel — Dimensions (Inches)

Hub Number	Bore Range A		Hub Diameter B	Bolt Circle C	Flange Diameter D	Bolt Holes		E	F	G*	L
	Stock	Maximum				Number	Bolt Size				
101	5/8	1 1/4	2 1/2	3 3/8	4 1/2	6	5/8	1/2	3/8	1 1/8	2
102	1 1/16	2	3	4	5	6	7/16	1/2	1/2	1 1/8	2 1/2
103	1 1/8	2 1/2	4	5 1/8	6	6	1/2	1/2	3/4	1 1/8	2 3/4
104	2 1/8	3	4 1/2	5 1/2	7	6	5/8	1/2	3/4	2	3 1/4
105	2 1/4	3 1/4	5	6 1/4	7 1/2	6	5/8	3/4	1 1/8	2 1/2	4
106	2 3/8	3 3/4	5 1/2	7	8 1/2	6	5/8	3/4	1	2 3/4	4
107	3 3/8	4	6	7 1/2	9	6	5/8	3/4	1 1/4	2 3/4	4 1/4
108	3 1/2	4 1/2	7	8 3/8	10 3/8	6	3/4	3/4	1 1/8	2 1/2	4 1/2
109	4 1/8	7	10 1/2	13	15 1/2	6	1	3/4	1 1/2	2 3/4	5

*Maximum bores shown are maximum bores with standard keyseat and setscrew.

ENGINEERED

ALTERATION CHARGES

See current list price and discount sheet for alteration charges.

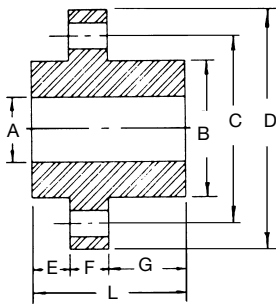

The List Price as shown in the List Price Book is for hub with stock bore. To obtain the price of a complete Type D sprocket add the List Price of hub plus alteration charges and the List Price of the desired Type A plate sprocket, including rebore, bolt hole drilling, and splitting charge if desired.

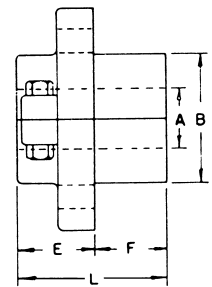
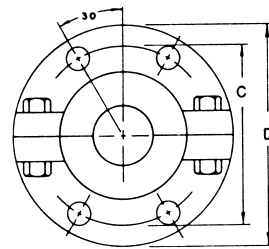

SOLID HUBS — STEEL

SPLIT HUBS — CAST IRON

Split Hubs - Cast Iron — Dimensions (Inches)

Hub Number	Bore Range A		Hub Diameter B	Bolt Circle C	Flange Diameter D	Bolt Holes		E	F*	L
	Stock	Maximum				Number	Bolt Size			
102S	1 1/16	1 1/4	3	4	5	4	7/16	1 1/4	1 3/8	3 1/2
103S	1 1/8	2 1/4	4	5 1/8	6	4	1/2	2	1 1/2	3 1/2
104S	2 1/8	2 3/4	4 1/2	5 1/2	7	4	5/8	2 1/4	1 3/4	4
105S	2 1/4	2 3/4	5	6 1/4	7 1/2	4	5/8	2 1/4	1 3/4	4 1/4
106S	2 3/8	3 1/4	5 1/2	7	8 1/2	4	5/8	2 1/2	2	4 1/4
107S	3 3/8	3 3/4	6	7 1/2	9	4	5/8	3	1 3/4	4 1/4
108S	3 1/2	4	7	8 3/8	10 3/8	4	3/4	3 3/8	1 3/4	5 1/4
109S	4 1/8	6	10 1/2	13	15 1/2	4	1	4 1/4	1 3/4	5 1/4

Maximum bores shown are maximum bores with standard keyseat and setscrew.

* Plate thickness of Accu-Torch not recommended if larger than dimension listed.

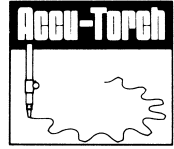

Shear pin sprockets provide simple, dependable protection against expensive machinery damage caused by overloads or jamming. Torque is transmitted by a single pin, necked to shear when the safe load is exceeded. When an overload occurs, the pin shears, disconnecting the drive immediately.

The Bolt-On Shear Pin Adapter converts any plate sprocket into a stock shear pin sprocket allowing immediate delivery of stock shear pin sprockets.

Selection guide on page F-9 gives complete procedure to select the proper shear pin assembly.

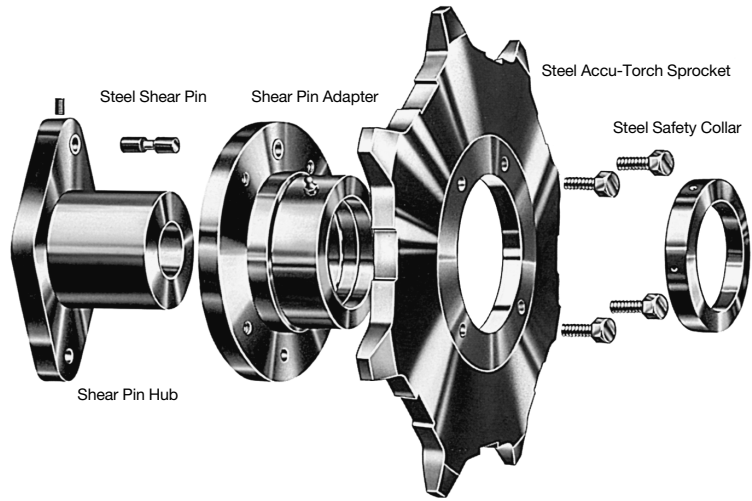

Stock Shear Pin Assemblies

Shear Pin Assembly Number	Hub Bore Range	Shear Pin Hub	Shear Pin Adapter
		Catalog Number	Catalog Number
SP-17	1" & UNDER	SPH-17	SPA-17
SP-18		SPH-18	SPA-18
SP-19		SPH-19	SPA-19
SP-20	1 ¹ / ₁₆ -1 ¹ / ₄	SPH-20	SPA-20
SP-21		SPH-21	SPA-21
SP-22		SPH-22	SPA-22
SP-23	2 ¹ / ₁₆ -2 ¹ / ₄	SPH-23	SPA-23
SP-24		SPH-24	SPA-24
SP-25		SPH-25	SPA-25
SP-26	3 ¹ / ₁₆ -3 ¹ / ₂	SPH-26	SPA-26
SP-27		SPH-27	SPA-27
SP-28		SPH-28	SPA-28
SP-29	4 ¹ / ₁₆ -5	SPH-29	SPA-29
SP-30		SPH-30	SPA-30
SP-31		SPH-31	SPA-31

NOTES ON PRICING:

Shear Pin Hub List Price includes any finished bore within the stated range, standard keyway and setscrew, hardened steel shear pin bushing.

Shear Pin Adapter List Price includes the shear pin bushing, grease fitting.

Complete Assembly List Price includes all components of the shear pin assembly as described above. Total list price of any shear pin sprocket is the complete assembly list price plus the list price of the desired plate sprocket (from tables of stock sprocket list prices).

Replacement Sprockets should be priced as altered stock sprockets directly from List Price and Alteration Charge tables.

Shear Pin Components may be ordered separately and will be treated as stock items when conforming to standard specifications and descriptions above.

PRICING EXAMPLES:

1. Stock Shear Pin Accu-Torch Sprocket

To price a 25 tooth shear pin sprocket for 1030 chain (1030SP25) using SP-26 shear pin assembly with 3¹/₁₆" bore, standard keyway and setscrew:

SP-26 Assembly	See List
1030A25	Price Sheet

2. Shear Pin Adapter and Sprocket for Existing Hub

To price a "Bolt-on" shear pin adapter and sprocket to replace the sprocket part of existing 78A12 using SP-20 hub:

SPA-20 Adapter	See List
78A12	Price Sheet

Shear Pin Sprockets can also be furnished in other standard styles or made to customers specifications. Price on application.

It is important that torque requirement for selected hub be checked in torque rating on page F-9 and neck diameter of shear pins be specified.

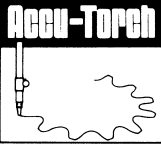

Bolt-On Shear Pin Accu-Torch® Sprockets

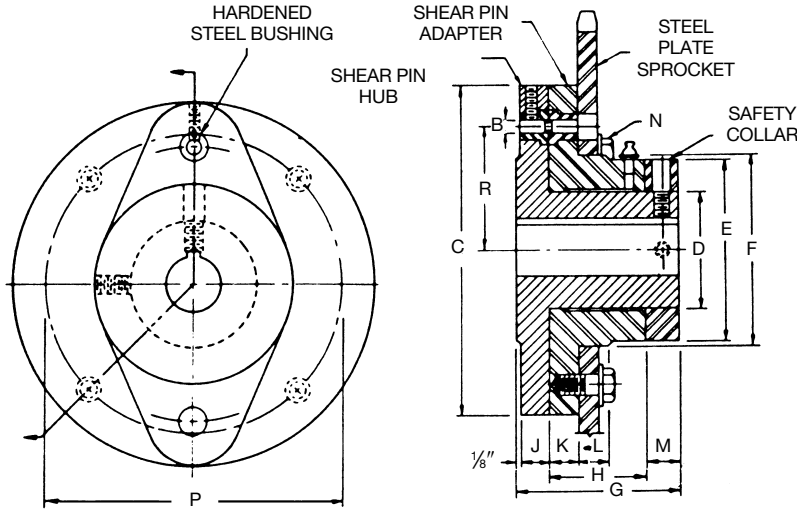

Sprocket Sizes for Stock Shear Pin Assemblies

Shear Pin Assembly Number	Hub Bore Range	Minimum Number of Teeth															
		Chain Number/Pitch															
		62 1.654	78 2.609	1568 3.067	1030 3.075	82 3.075	238 3.500	124 4.000	1240 4.063	635 4.500	1207 5.000	132 6.050					
SP-19	1 $\frac{1}{8}$ -1 $\frac{1}{2}$	16															
SP-20	1 $\frac{1}{8}$ -1 $\frac{1}{2}$	17	12														
SP-21	1 $\frac{1}{8}$ -2	19	13			11											
SP-22	2 $\frac{1}{8}$ -2 $\frac{1}{2}$	21	14	13	13	12	12										
SP-23	2 $\frac{1}{8}$ -2 $\frac{1}{2}$	22	15	14	13	13	12	10									
SP-24	2 $\frac{1}{8}$ -2 $\frac{1}{2}$	25	16	15	15	14	13	11	12	11							
SP-25	2 $\frac{1}{8}$ -3	26	18	16	16	15	14	12	13	12							
SP-26	3 $\frac{1}{8}$ -3 $\frac{1}{2}$	28	19	17	17	16	15	13	13	13							
SP-27	3 $\frac{1}{8}$ -4	32	21	19	19	18	17	14	15	14							
SP-28	4 $\frac{1}{8}$ -4 $\frac{1}{2}$	34	22	20	20	19	18	15	15	15							
SP-29	4 $\frac{1}{8}$ -5	36	24	21	21	20	19	16	16	15							
SP-30	4 $\frac{1}{8}$ -5 $\frac{1}{2}$	41	27	24	23	23	21	18	18	17							
SP-31	5 $\frac{1}{8}$ -6	45	30	26	25	25	23	20	20	19							

AVAILABLE AS MADE TO ORDER
CHECK YOUR NEAREST MARTIN FACILITY

Shear Pin Assembly Dimensions (Inches)

Shear Pin Assembly Number	Shear Pin		Diameters				Length Thru			Hub Flange Thickness	Adapter Flange Thickness	Sprocket Seat Width	Bolts		Weight (lbs.)	
	Radius	Pin Diameter	Flange	Shear Pin Hub	Adapter Hub & Collar	Sprocket Seat	Shear Pin Hub	Adapter	Collar				Number & Size	Bolt Circle	Shear Pin Hub	Shear Pin Adapter
SP-19	2 $\frac{1}{16}$	$\frac{3}{16}$	6 $\frac{1}{4}$	2 $\frac{3}{4}$	4	4 $\frac{1}{2}$	3 $\frac{3}{8}$	2 $\frac{1}{2}$	$\frac{3}{8}$	$\frac{1}{16}$	$\frac{1}{16}$	$\frac{1}{16}$	4- $\frac{1}{2}$ "	5 $\frac{1}{2}$	7.2	7.6
SP-20	3	$\frac{3}{8}$	7 $\frac{1}{4}$	3 $\frac{3}{4}$	4 $\frac{1}{4}$	4 $\frac{1}{4}$	4 $\frac{1}{8}$	2 $\frac{1}{2}$	$\frac{3}{4}$	$\frac{1}{8}$	$\frac{1}{8}$	$\frac{1}{8}$	4- $\frac{1}{2}$ "	6 $\frac{1}{4}$	11.0	11.9
SP-21	3 $\frac{3}{8}$	$\frac{7}{8}$	8 $\frac{1}{4}$	3 $\frac{3}{4}$	5 $\frac{1}{4}$	5 $\frac{1}{4}$	4 $\frac{1}{8}$	2 $\frac{1}{2}$	$\frac{7}{8}$	$\frac{1}{8}$	$\frac{1}{8}$	$\frac{1}{8}$	4- $\frac{3}{8}$ "	7	16.2	16.9
SP-22	3 $\frac{3}{8}$	$\frac{1}{2}$	9 $\frac{1}{4}$	4 $\frac{1}{4}$	6 $\frac{1}{4}$	6 $\frac{1}{4}$	5 $\frac{1}{8}$	3	1	$\frac{1}{16}$	$\frac{1}{16}$	$\frac{1}{16}$	4- $\frac{3}{8}$ "	8	23.3	24.5
SP-23	4	$\frac{1}{2}$	10	4 $\frac{1}{2}$	6 $\frac{1}{2}$	6 $\frac{1}{2}$	5 $\frac{1}{16}$	3 $\frac{1}{2}$	1	$\frac{1}{16}$	$\frac{1}{16}$	$\frac{1}{16}$	4- $\frac{3}{8}$ "	8 $\frac{1}{4}$	26.3	27.7
SP-24	4 $\frac{1}{8}$	$\frac{5}{8}$	11 $\frac{1}{2}$	5	7	7 $\frac{1}{2}$	6 $\frac{1}{8}$	3 $\frac{1}{2}$	1 $\frac{1}{8}$	$\frac{1}{16}$	$\frac{1}{16}$	$\frac{1}{16}$	4- $\frac{5}{8}$ "	9 $\frac{1}{4}$	40.4	38.6
SP-25	4 $\frac{1}{8}$	$\frac{3}{4}$	12 $\frac{1}{2}$	5 $\frac{1}{2}$	8	8 $\frac{1}{2}$	6 $\frac{3}{8}$	4 $\frac{1}{4}$	1 $\frac{1}{4}$	$\frac{1}{16}$	$\frac{1}{16}$	$\frac{1}{16}$	6- $\frac{3}{8}$ "	10 $\frac{1}{4}$	52.6	53.6
SP-26	5 $\frac{1}{8}$	$\frac{1}{16}$	13 $\frac{1}{2}$	6 $\frac{1}{4}$	8 $\frac{1}{4}$	8 $\frac{1}{4}$	7 $\frac{1}{16}$	4 $\frac{1}{2}$	1 $\frac{1}{2}$	$\frac{1}{16}$	$\frac{1}{16}$	$\frac{1}{16}$	6- $\frac{3}{8}$ "	11 $\frac{1}{4}$	66.7	66.8
SP-27	6 $\frac{1}{8}$	$\frac{3}{4}$	15 $\frac{1}{2}$	7	10	10 $\frac{1}{4}$	8 $\frac{1}{16}$	5 $\frac{1}{2}$	1 $\frac{1}{2}$	$\frac{1}{16}$	$\frac{1}{16}$	$\frac{1}{16}$	6- $\frac{3}{8}$ "	12 $\frac{1}{4}$	96.5	100.0
SP-28	6 $\frac{1}{8}$	$\frac{3}{4}$	16 $\frac{1}{4}$	7 $\frac{3}{4}$	10 $\frac{3}{4}$	10 $\frac{3}{4}$	9 $\frac{1}{16}$	6 $\frac{1}{2}$	1 $\frac{1}{2}$	$\frac{1}{16}$	$\frac{1}{16}$	$\frac{1}{16}$	6- $\frac{3}{4}$ "	13 $\frac{1}{2}$	125.0	115.0
SP-29	7 $\frac{1}{8}$	$\frac{7}{8}$	17 $\frac{1}{2}$	8 $\frac{1}{2}$	12	12 $\frac{1}{2}$	10 $\frac{1}{16}$	7	1 $\frac{1}{4}$	$\frac{1}{16}$	$\frac{1}{16}$	$\frac{1}{16}$	6-1"	14 $\frac{3}{4}$	160.0	150.0
SP-30	8 $\frac{1}{8}$	1	20 $\frac{1}{4}$	9 $\frac{1}{2}$	13 $\frac{3}{4}$	13 $\frac{3}{4}$	11 $\frac{1}{16}$	7 $\frac{1}{2}$	2	$\frac{1}{16}$	$\frac{1}{16}$	$\frac{1}{16}$	6-1"	17	215.0	207.0
SP-31	8 $\frac{1}{8}$	1 $\frac{1}{8}$	22 $\frac{1}{2}$	10 $\frac{3}{4}$	15	15 $\frac{1}{2}$	12 $\frac{3}{16}$	8 $\frac{1}{4}$	2 $\frac{1}{4}$	$\frac{1}{16}$	$\frac{1}{16}$	$\frac{1}{16}$	6-1"	18 $\frac{3}{4}$	318.0	265.0

ENGINEERED



Bolt-On Shear Pin Accu-Torch® Sprockets

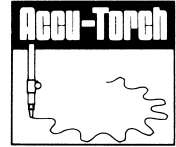

Shear Pin Sprocket Selection

- The shear pin assembly required is determined by the shaft size. Select the smallest shear pin assembly which will accommodate the required bore. Table on page 130 contains the bore ranges and minimum sprocket sizes which allow chain clearance over the shear pin assembly flange.
- Using one of the following formulas, compute the torque load the pin must transmit and enter the torque rating table below to obtain the proper shear pin neck diameter.

$$T = \frac{HP \times 63,000 \times 1.5}{RPM} \quad \text{or} \quad T = \frac{D \times CP \times 1.5}{2}$$

or $T = \text{Output of reducer} \times \text{speed ratio of chain drive} \times 1.5$

Where:

- T = Torque in pound inches
- HP = Horsepower at sprocket
- RPM = Sprocket speed
- D = Pitch diameter of sprocket
- CP = Chain pull in pounds
- 1.5 = Safety factor for starting load

EXAMPLE:

- Determine the shear pin assembly and pin neck diameter to transmit 20 horsepower at 67 RPM with a 36 tooth, No. 62 sprocket on a 2^{15/16}" shaft.

(1) Referring to Table I, shear pin assembly SP-25 is required for a 2^{15/16}" bore. The 36 tooth sprocket is well above the minimum size.

(2) Torque and neck diameter:

$$T = \frac{HP \times 63,000 \times 1.5}{RPM}$$

$$T = \frac{20 \times 63,000 \times 1.5}{67} = 28,200 \text{ lb. in.}$$

Referring to Table II under SP-25, a pin necked to ³/₈" shows a torque rating of 29,810 lb. in., which exceeds the 28,200 lb. in. required.

(3) Order: 62SP36, SP-25 assembly with 2^{15/16}" bore and ³/₈" pin neck diameter.

Shear Pin Torque Ratings

Shear Pin Neck Diameter (Inches)	Torque Rating — Pound Inches												
	Shear Pin Hub Number												
	SP19	SP20	SP21	SP22	SP23	SP24	SP25	SP26	SP27	SP28	SP29	SP30	SP31
³ / ₃₂	1022	1204	1323	1556	1603								
¹ / ₁₆	1752	2064	2268	2616	2748								
⁵ / ₃₂	2774	3268	3591	4142	4351	4750							
³ / ₁₆	3942	4944	5103	5886	6183	6750	7317						
⁷ / ₃₂	5402	6364	6993	8066	8473	9250	10027						
¹ / ₈	7300	8600	9450	10900	11450	12500	13550	15200	17300	18400			
⁹ / ₃₂	9052	10664	11718	13516	14198	15500	16802	18848	21452	22816			
⁵ / ₁₆	11096	13072	14364	16568	17403	19000	20596	23140	26296	27968	30932		
¹¹ / ₃₂		15824	17388	20056	21068	23000	24932	27968	31832	33856	37440		
³ / ₈		18920	20790	23980	25190	27500	29810	33440	38060	40480	44770	51040	
¹³ / ₃₂			24570	28340	29170	32500	35230	39520	44980	47840	52910	60320	
⁷ / ₁₆			28350	32700	34350	37500	41650	45600	51900	55200	61050	69600	
¹⁵ / ₃₂				37060	38930	42500	46070	51680	58820	62560	69190	78880	
¹ / ₂				42728	44884	49000	53116	59584	67816	72128	79772	90944	
¹⁷ / ₃₂						55000	59620	66880	76120	80960	89540	102080	
⁹ / ₁₆						62000	67280	75392	85808	91264	100936	115072	
¹⁹ / ₃₂							73220	82080	93420	99360	109890	125280	136890
⁵ / ₈							82800	92720	105530	112240	124135	141520	154635
²¹ / ₃₂								103360	117640	126120	138380	157760	172380
¹¹ / ₁₆								112480	128020	136160	150590	171680	187590
²³ / ₃₂									138400	147200	162800	185600	202800
³ / ₄									152240	161920	179080	204160	223080
²⁵ / ₃₂											195360	222720	243360
¹³ / ₁₆											211640	241280	263640
²⁷ / ₃₂											227920	259840	283920
⁷ / ₈											244200	278400	304200
²⁹ / ₃₂												296960	324480
¹⁵ / ₁₆												301600	329550
³¹ / ₃₂												338720	370110
1												371200	405600
¹ / ₁₆													446160
¹ / ₈													507000

ENGINEERED

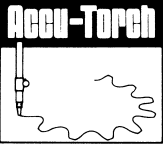

Flame Cut Sprockets For Engineering Chains



Conveyor Style Tooth for Chains:
78 — 82 — 124 — 132



Driver Style Tooth for Chains:
62 — 1568 — 1030 — 238 — 1240 — 635

ENGINEERED

Typical "Drive" & "Conveyor" Sprocket Tooth Form

 NOTE: All *Martin* Accu-Torch Sprockets have chamfered teeth for proper chain engagement.

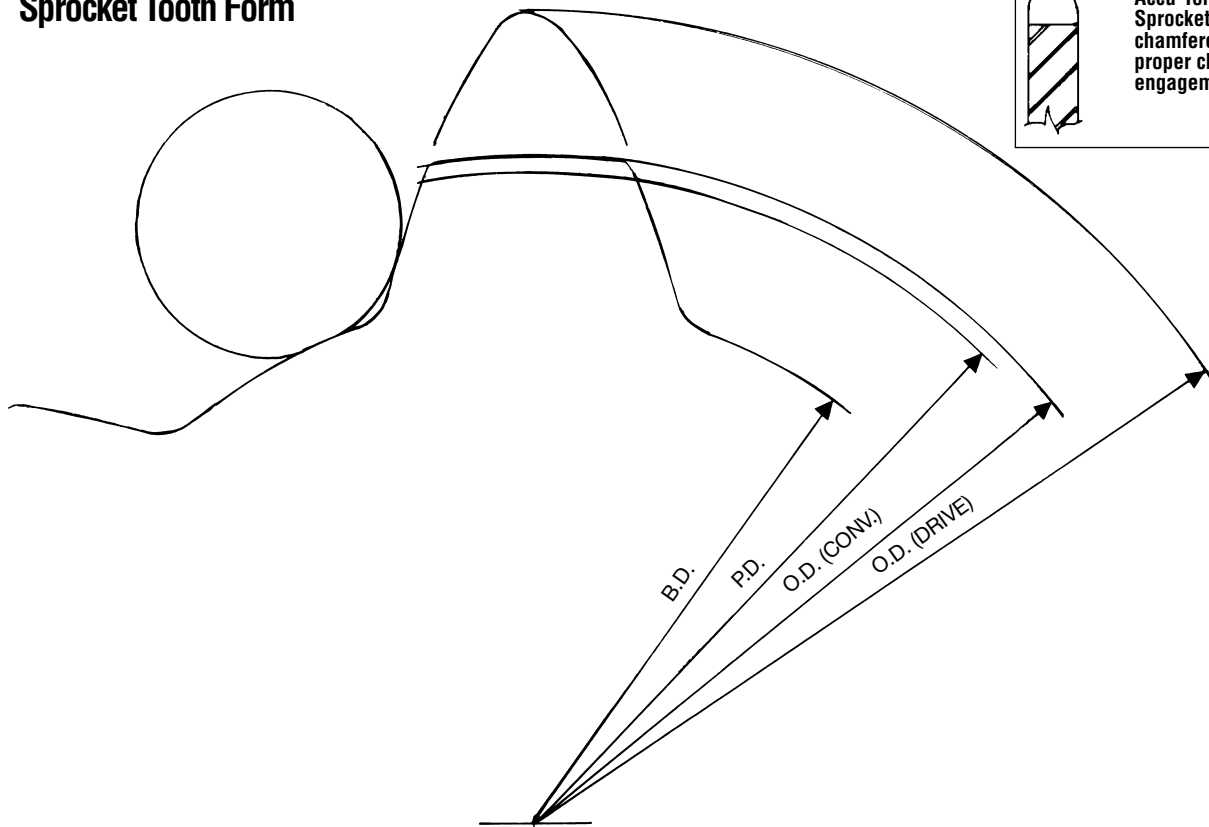

Accu-Torch Sprockets are not intended to replace cut tooth roller chain sprockets.

NOTE: For style other than Type "C" or Type "A", or Tooth Size not shown, consult factory for price. See Current List Price Sheet for Stock Pricing.



Flame Cut Sprockets for Engineering Chains

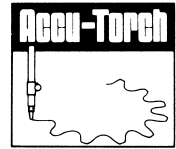

62 FLAME CUT SPROCKETS FOR CHAINS:

62 CAST — 2 — 062 — 62 Steel — 62A — HF 62 A — 62 H — H 62 — 072 — 72½ — 162 — R 362 — RR 362 — R432 — RR 432 — 962 — LXS 627 — IS 620 — 162 R — US 622 — 378 R — 402 RX — US 620

Type C — 1.654" Pitch

PLATE THICKNESS 3/4"
ROLLER DIAMETER 13/16"

Type A

Number of Teeth	Catalog Number	Pitch Diameter	Stock Bore	Max. Bore	Hub Diameter	L.T.B.	Approximate Weight	Catalog Number	Stock Bore	Approximate Weight
12	62C12	6.39	5/16	23/4	43/4	33/8	15.8	62A12	15/16	6.8
13	62C13	6.91	5/16	33/8	43/4	3	19.4	62A13	15/16	8
14	62C14	7.43	5/16	33/8	43/4	3	20.6	62A14	15/16	9.2
15	62C15	7.96	5/16	33/8	43/4	3	22	62A15	15/16	10.5
17	62C17	9.00	5/16	33/8	43/4	3	24	62A17	15/16	12
19	62C19	10.05	5/16	33/8	43/4	3	28	62A19	15/16	16.8
20	62C20	10.57	5/16	33/8	43/4	3	30	62A20	15/16	18.6
24	62C24	12.67	13/16	33/8	51/2	43/8	49	62A24	13/16	26
26	62C26	13.72	13/16	33/8	51/2	43/8	53	62A26	13/16	30
30	62C30	15.82	13/16	33/8	51/2	43/8	65	62A30	13/16	42
36	62C36	18.98	13/16	33/8	51/2	43/8	82	62A36	13/16	59
54	62C54	28.45	13/16	33/8	51/2	43/8	125	62A54	13/16	135
60	62C60	31.60	13/16	33/8	51/2	43/8	138	62A60	13/16	169

78 FLAME CUT SPROCKETS FOR CHAINS:

78 — H 74 — 75 — H 75 — H 78 — H 78 LR — (14 — 18 TEETH ONLY) — H 78 RT — H 78 SR — H 79 — 88 — 188 — S 188 — S 78 — R 588 — RR 588 — R 778 — RR 778 — 988 — IS 880 — 87R — IS 881 — 81X — IS 882 — 433½ — LXS 881 — LXS 886 — US 881 — LXS 887 — LXS 882 — 488 — XS 578 — SS 188 — C 188 — US 278 R — US 882 — 578 R — 588 R

Type C — 2.609" Pitch

PLATE THICKNESS 7/8"
ROLLER DIAMETER 13/8"

Type A

Number of Teeth	Catalog Number	Pitch Diameter	Stock Bore	Max. Bore	Hub Diameter	L.T.B.	Approximate Weight	Catalog Number	Stock Bore	Approximate Weight
8	78C8	6.82	5/16	33/8	43/4	33/8	21	78A8	15/16	9
9	78C9	7.63	13/16	33/8	53/8	33/8	29	78A9	13/16	11.3
10	78C10	8.44	13/16	33/8	53/8	33/8	31	78A10	13/16	13.9
11	78C11	9.26	13/16	33/8	53/8	33/8	34	78A11	13/16	16.7
12	78C12	10.08	13/16	33/8	53/8	33/8	37	78A12	13/16	19.8
13	78C13	10.90	13/16	33/8	53/8	43/8	46	78A13	13/16	23
14	78C14	11.72	13/16	33/8	53/8	43/8	49	78A14	13/16	27
15	78C15	12.55	13/16	33/8	53/8	43/8	53	78A15	13/16	30
17	78C17	14.20	13/16	33/8	53/8	43/8	62	78A17	13/16	39
19	78C19	15.85	13/16	43/8	63/8	53/8	90	78A19	13/16	50
21	78C21	17.51	13/16	43/8	63/8	53/8	101	78A21	13/16	61
24	78C24	19.99	13/16	43/8	63/8	53/8	119	78A24	13/16	79
25	78C25	20.82	13/16	43/8	63/8	53/8	124	78A25	13/16	84
28	78C28	23.31	13/16	43/8	63/8	53/8	132	78A28	13/16	105
30	78C30	24.96	13/16	43/8	63/8	53/8	150	78A30	13/16	123
35	78C35	29.11	13/16	43/8	63/8	53/8	170	78A35	13/16	166
40	78C40	33.25	13/16	43/8	73/8	63/8	226	78A40	13/16	216
42	78C42	34.91	13/16	43/8	73/8	63/8	240	78A42	13/16	240
46	78C46	38.31	13/16	43/8	73/8	63/8	258	78A46	13/16	286
54	78C54	44.87	13/16	43/8	73/8	63/8	368	78A54	13/16	302
60	78C60	49.85	13/16	43/8	73/8	63/8	388	78A60	13/16	322

78 BORED-TO-SIZE FLAME CUT SPROCKETS

Type C — 2.609" Pitch

PLATE THICKNESS 7/8"
ROLLER DIAMETER 13/8"

Part Number	Pitch Diameter	Approximate Wt. Lbs.	Stock Finished Bores - Includes Keyway & 2 Setscrews							
78CS8	6.82"	21	1-7/16	1-15/16	2	2-3/16	2-7/16	2-15/16		
78CS9	7.63"	29	1-7/16	1-15/16	2	2-3/16	2-7/16	2-15/16		
78CS10	8.44"	31	1-7/16	1-15/16	2	2-3/16	2-7/16	2-15/16	3-7/16*	
78CS11	9.26"	34		1-15/16	2	2-3/16	2-7/16	2-15/16	3-7/16*	
78CS12	10.08"	37		1-15/16	2	2-3/16	2-7/16	2-15/16	3-7/16*	
78CS13	10.90"	46		1-15/16	2	2-3/16	2-7/16	2-15/16	3-7/16*	
78CS14	11.72"	49		1-15/16	2	2-3/16	2-7/16	2-15/16	3-7/16*	

Please contact *Martin* if Hub OD and Length Thru Bore dimensions are critical.

* These parts have setscrews at 90 degrees and 180 degrees instead of over keyway and 90 degrees.

ENGINEERED

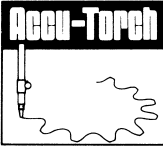

Flame Cut Sprockets for Engineering Chains



1568 FLAME CUT SPROCKETS FOR CHAINS:

AX 1568 — X568 — JS 3011 — SS 568 — XX 568 — 1803 A — 1803 AB — MXS 3011 — IS 3011 — IS 3010 — US 3011 — LXS 3011 — LXS 3011 M

Type C — 3.067" Pitch

PLATE THICKNESS 1¹/₄"
ROLLER DIAMETER 1⁵/₈"

Type A

Number of Teeth	Catalog Number	Pitch Diameter	Stock Bore	Max. Bore	Hub Diameter	L.T.B.	Approximate Weight	Catalog Number	Stock Bore	Approximate Weight
10	1568C10	9.92	1 ¹ / ₂	3 ³ / ₄	5 ¹ / ₂	4 ¹ / ₄	46	1568A10	1 ¹ / ₂	28
12	1568C12	11.85	1 ¹ / ₂	3 ³ / ₄	5 ¹ / ₂	4 ¹ / ₄	58	1568A12	1 ¹ / ₂	40
14	1568C14	13.78	1 ¹ / ₂	3 ³ / ₄	5 ¹ / ₂	4 ¹ / ₄	73	1568A14	1 ¹ / ₂	53
30	1568C30	29.34	1 ¹ / ₂	4 ¹ / ₂	6 ¹ / ₂	5 ¹ / ₂	217	1568A30	1 ¹ / ₂	240
36	1568C36	35.19	1 ¹ / ₂	5 ¹ / ₂	7 ¹ / ₂	5 ¹ / ₂	257	1568A36	1 ¹ / ₂	290
42	1568C42	41.04	1 ¹ / ₂	5 ¹ / ₂	8	6 ¹ / ₂	407	1568A42	1 ¹ / ₂	340
48	1568C48	46.89	1 ¹ / ₂	5 ¹ / ₂	8	6 ¹ / ₂	448	1568A48	1 ¹ / ₂	381

ENGINEERED

1030 FLAME CUT SPROCKETS FOR CHAINS:

1030 — CHAMPION NO. 3 — R 1033 — R 1035 — 1037 — 1539 — SS 40 — LXS 1031 — API 3 — LXS 1032 — SS 40 Hyp — IS 1030 — IS 1031 — IS 1032 — IS 1037 — US 1031 — 1190 — SXX — 1190 R — US 1032

Type C — 3.075" Pitch

PLATE THICKNESS 1¹/₄"
ROLLER DIAMETER 1¹/₄"

Type A

Number of Teeth	Catalog Number	Pitch Diameter	Stock Bore	Max. Bore	Hub Diameter	L.T.B.	Approximate Weight	Catalog Number	Stock Bore	Approximate Weight
8	1030C8	8.05	1 ¹ / ₄	3 ³ / ₄	5	3 ³ / ₄	31	1030A8	1 ¹ / ₄	17.9
9	1030C9	8.99	1 ¹ / ₄	3 ³ / ₄	5	3 ³ / ₄	36	1030A9	1 ¹ / ₄	22.4
10	1030C10	9.95	1 ¹ / ₄	3 ³ / ₄	5	3 ³ / ₄	40	1030A10	1 ¹ / ₄	28
11	1030C11	10.91	1 ¹ / ₄	3 ³ / ₄	5 ¹ / ₂	4 ¹ / ₄	51	1030A11	1 ¹ / ₂	33
12	1030C12	11.88	1 ¹ / ₄	3 ³ / ₄	5 ¹ / ₂	4 ¹ / ₄	57	1030A12	1 ¹ / ₂	39
13	1030C13	12.85	1 ¹ / ₄	3 ³ / ₄	5 ¹ / ₂	4 ¹ / ₄	64	1030A13	1 ¹ / ₂	46
15	1030C15	14.79	1 ¹ / ₄	4	6	5 ¹ / ₂	91	1030A15	1 ¹ / ₂	60
17	1030C17	16.73	1 ¹ / ₄	4	6	5 ¹ / ₂	109	1030A17	1 ¹ / ₂	78
19	1030C19	18.68	1 ¹ / ₂	4 ¹ / ₂	6 ¹ / ₂	5 ¹ / ₂	137	1030A19	1 ¹ / ₂	97
21	1030C21	20.63	1 ¹ / ₂	4 ¹ / ₂	6 ¹ / ₂	5 ¹ / ₂	158	1030A21	1 ¹ / ₂	118
24	1030C24	23.56	1 ¹ / ₂	4 ¹ / ₂	6 ¹ / ₂	5 ¹ / ₂	176	1030A24	1 ¹ / ₂	154
25	1030C25	24.53	1 ¹ / ₂	5 ¹ / ₂	7 ¹ / ₂	5 ¹ / ₂	206	1030A25	1 ¹ / ₂	167
28	1030C28	27.46	1 ¹ / ₂	5 ¹ / ₂	7 ¹ / ₂	5 ¹ / ₂	236	1030A28	1 ¹ / ₂	210
30	1030C30	29.42	1 ¹ / ₂	5 ¹ / ₂	7 ¹ / ₂	5 ¹ / ₂	254	1030A30	1 ¹ / ₂	240
35	1030C35	34.30	1 ¹ / ₂	5 ¹ / ₂	8	6 ¹ / ₂	313	1030A35	1 ¹ / ₂	327
40	1030C40	39.19	1 ¹ / ₂	5 ¹ / ₂	8	6 ¹ / ₂	360	1030A40	1 ¹ / ₂	427
42	1030C42	41.15	1 ¹ / ₂	5 ¹ / ₂	8	6 ¹ / ₂	410	1030A42	1 ¹ / ₂	343
48	1030C48	47.03	1 ¹ / ₂	6 ¹ / ₂	9 ¹ / ₂	6 ¹ / ₂	501	1030A48	1 ¹ / ₂	384
54	1030C54	52.89	1 ¹ / ₂	6 ¹ / ₂	9 ¹ / ₂	6 ¹ / ₂	549	1030A54	1 ¹ / ₂	432
60	1030C60	58.75	1 ¹ / ₂	7	10	7 ¹ / ₂	642	1030A60	1 ¹ / ₂	506

Maximum bores shown will accommodate standard keyseat and setscrew over keyseat. Slightly larger bores are possible with no keyseat, shallow keyseat, or setscrew at angle to keyseat.



Flame Cut Sprockets for Engineering Chains

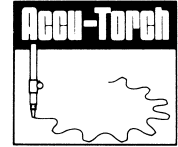

82 FLAME CUT SPROCKETS FOR CHAINS:

H 82 — WH 82 — WR 82 — 103 — 131 — S 131 — WS 82 — WS 82 H — SS 131 — 527 R — 527 RX — C 9103 — 6131 — 4103 — C 131 — 382

Type C — 3.075" Pitch

PLATE THICKNESS 1¹/₈"
ROLLER DIAMETER 1⁷/₃₂"

Type A

Number of Teeth	Catalog Number	Pitch Diameter	Stock Bore	Max. Bore	Hub Diameter	L.T.B.	Approximate Weight	Catalog Number	Stock Bore	Approximate Weight
7	82C7	7.09	1 ¹ / ₈	2 ¹ / ₈	4 ¹ / ₂	3 ³ / ₈	24	82A7	1 ¹ / ₈	12.6
8	82C8	8.04	1 ¹ / ₈	3 ¹ / ₈	5 ¹ / ₂	4 ¹ / ₂	34	82A8	1 ¹ / ₈	16
9	82C9	8.99	1 ¹ / ₈	3 ³ / ₈	5 ¹ / ₂	4 ¹ / ₂	38	82A9	1 ¹ / ₈	20
10	82C10	9.95	1 ¹ / ₈	3 ³ / ₈	5 ¹ / ₂	4 ¹ / ₂	43	82A10	1 ¹ / ₈	25
11	82C11	10.91	1 ¹ / ₈	3 ³ / ₈	5 ¹ / ₂	4 ¹ / ₂	54	82A11	1 ¹ / ₈	30
12	82C12	11.88	1 ¹ / ₈	3 ³ / ₈	5 ¹ / ₂	4 ¹ / ₂	60	82A12	1 ¹ / ₈	36
13	82C13	12.85	1 ¹ / ₈	3 ³ / ₈	5 ¹ / ₂	4 ¹ / ₂	66	82A13	1 ¹ / ₈	42
14	82C14	13.82	1 ¹ / ₈	3 ³ / ₈	5 ¹ / ₂	4 ¹ / ₂	72	82A14	1 ¹ / ₈	48
15	82C15	14.79	1 ¹ / ₈	4 ¹ / ₂	6 ¹ / ₂	5 ¹ / ₂	94	82A15	1 ¹ / ₈	54
16	82C16	15.76	1 ¹ / ₈	4 ¹ / ₂	6 ¹ / ₂	5 ¹ / ₂	102	82A16	1 ¹ / ₈	62
17	82C17	16.73	1 ¹ / ₈	4 ¹ / ₂	6 ¹ / ₂	5 ¹ / ₂	110	82A17	1 ¹ / ₈	70
18	82C18	17.71	1 ¹ / ₈	4 ¹ / ₂	6 ¹ / ₂	5 ¹ / ₂	119	82A18	1 ¹ / ₈	79

82 BORED-TO-SIZE FLAME CUT SPROCKETS

Type C — 3.075" Pitch

PLATE THICKNESS 1¹/₈"
ROLLER DIAMETER 1⁷/₃₂"

Part Number	Pitch Diameter	Approximate Wt. Lbs.	Stock Finished Bores - Includes Keyway & 2 Setscrews
82CS10	9.95"	43	2-7/16 2-15/16
82CS11	10.91"	54	2-7/16 2-15/16
82CS12	11.88"	60	2-7/16 2-15/16

Please contact *Martin* if Hub OD and Length Thru Bore dimensions are critical.

238 FLAME CUT SPROCKETS FOR CHAINS:

RX 238 — IS 3514 J — 1616 A — MXS 3514 — US 3514 — LXS 3514 — LXS 3514 M

Type C — 3.500" Pitch

PLATE THICKNESS 1¹/₄"
ROLLER DIAMETER 1³/₄"

Type A

Number of Teeth	Catalog Number	Pitch Diameter	Stock Bore	Max. Bore	Hub Diameter	L.T.B.	Approximate Weight	Catalog Number	Stock Bore	Approximate Weight
10	238C10	11.33	1 ¹ / ₂	3 ³ / ₈	5 ¹ / ₂	4 ¹ / ₂	54	238A10	1 ¹ / ₂	35
12	238C12	13.52	1 ¹ / ₂	3 ³ / ₈	5 ¹ / ₂	4 ¹ / ₂	70	238A12	1 ¹ / ₂	51
14	238C14	15.73	1 ¹ / ₂	3 ³ / ₈	5 ¹ / ₂	4 ¹ / ₂	88	238A14	1 ¹ / ₂	60
30	238C30	33.48	1 ¹ / ₂	4	6	5 ¹ / ₂	312	238A30	1 ¹ / ₂	253
36	238C36	40.16	1 ¹ / ₂	4	6	5 ¹ / ₂	445	238A36	1 ¹ / ₂	370
42	238C42	46.84	1 ¹ / ₂	5 ¹ / ₂	8	6 ¹ / ₂	446	238A42	1 ¹ / ₂	379
48	238C48	53.52	1 ¹ / ₂	5 ¹ / ₂	8	6 ¹ / ₂	517	238A48	1 ¹ / ₂	450

Maximum bores shown will accommodate standard keyseat and setscrew over keyseat. Slightly larger bores are possible with no keyseat, shallow keyseat, or setscrew at angle to keyseat.

ENGINEERED

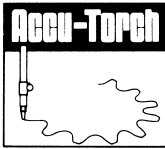

Flame Cut Sprockets for Engineering Chains



124 FLAME CUT SPROCKETS FOR CHAINS:

H 124 — W 124 — WS 124 — WR 124 — WH 124

Type C — 4.000" Pitch

PLATE THICKNESS 1 1/2"
ROLLER DIAMETER 1 1/2"

Type A

Number of Teeth	Catalog Number	Pitch Diameter	Stock Bore	Max. Bore	Hub Diameter	L.T.B.	Approximate Weight	Catalog Number	Stock Bore	Approximate Weight
6	124C6	8.00	5/16	3/4	4 3/4	4%	36	124A6	5/16	21
7	124C7	9.22	1	3 3/8	5%	4%	52	124A7	1	28
8	124C8	10.45	1	3 3/8	5%	4%	61	124A8	1	37
9	124C9	11.70	1	3 3/8	5%	4%	70	124A9	1	46
10	124C10	12.94	1	3 3/8	5%	4%	79	124A10	1	55
11	124C11	14.20	1 1/2	4%	6%	4%	95	124A11	1 1/2	68
12	124C12	15.45	1 1/2	4%	6%	4%	107	124A12	1 1/2	80
13	124C13	16.72	1 1/2	4%	6%	4%	120	124A13	1 1/2	93
14	124C14	17.98	1 1/2	4%	6%	4%	135	124A14	1 1/2	108
15	124C15	19.24	1 1/2	4%	6%	6	168	124A15	1 1/2	124
16	124C16	20.50	1 1/2	4%	6%	6	185	124A16	1 1/2	141

124 BORED-TO-SIZE FLAME CUT SPROCKETS

Type C — 4.000" Pitch

PLATE THICKNESS 1 1/2"
ROLLER DIAMETER 1 1/2"

Part Number	Pitch Diameter	Approximate Wt. Lbs.	Stock Finished Bores - Includes Keyway & 2 Setscrews			
124CS9	11.70"	70	2-3/16	2-7/16	2-15/16	
124CS10	12.94"	79		2-7/16	2-15/16	3-7/16
124CS11	14.20"	95			2-15/16	3-7/16
124CS12	15.45"	107			2-15/16	3-7/16

Please contact *Martin* if Hub OD and Length Thru Bore dimensions are critical.

1240 FLAME CUT SPROCKETS FOR CHAINS:

1240 — CHAMPION NO. 4 — 1244 — RX 1245 — R 1248 — SS 124 — API 4 — LXS 1242 — SS 124 — 3 BAR HYPER — LXS 1245 — SS 124 D — SS 124 DP — IS 1242 — IS 1245

Type C — 4.063" Pitch

PLATE THICKNESS 1 3/4"
ROLLER DIAMETER 1 3/4"

Type A

Number of Teeth	Catalog Number	Pitch Diameter	Stock Bore	Max. Bore	Hub Diameter	L.T.B.	Approximate Weight	Catalog Number	Stock Bore	Approximate Weight
6	1240C6	8.13	5/16	2 1/2	4	4	34	1240A6	5/16	26
7	1240C7	9.36	1 1/4	3%	5%	4%	51	1240A7	1 1/4	34
8	1240C8	10.62	1 1/4	4%	6%	5	78	1240A8	1 1/4	44
9	1240C9	11.88	1 1/4	4%	6%	5	89	1240A9	1 1/4	55
10	1240C10	13.15	1 1/2	4%	6%	5	101	1240A10	1 1/2	67
11	1240C11	14.42	1 1/2	4%	6%	5	115	1240A11	1 1/2	81
12	1240C12	15.70	1 1/2	5%	7	6	140	1240A12	1 1/2	96
13	1240C13	16.98	1 1/2	5%	7	6	155	1240A13	1 1/2	111
14	1240C14	18.26	1 1/2	5%	7	6	174	1240A14	1 1/2	130
15	1240C15	19.54	1 1/2	5%	7	6	192	1240A15	1 1/2	148
16	1240C16	20.83	1 1/2	5%	8	6%	230	1240A16	1 1/2	168
18	1240C18	23.40	1 1/2	5%	8	6%	275	1240A18	1 1/2	213
20	1240C20	25.97	1 1/2	5 1/2	8	6%	300	1240A20	1 1/2	263
21	1240C21	27.26	1 1/2	5 1/2	8	6%	319	1240A21	1 1/2	289
24	1240C24	31.12	1 1/2	5 1/2	8	6%	387	1240A24	1 1/2	377
25	1240C25	33.42	1 1/2	6	9	6%	426	1240A25	1 1/2	409
28	1240C28	36.29	1 1/2	6	9	6%	494	1240A28	1 1/2	509
30	1240C30	38.87	1 1/2	7	10	6%	583	1240A30	1 1/2	587
35	1240C35	45.33	1 1/2	7	10	6%	729	1240A35	1 1/2	620
40	1240C40	51.78	1 1/2	7 1/2	11	7%	932	1240A40	1 1/2	721
48	1240C48	62.12	1 1/2	7 1/2	11	7%	1078	1240A48	1 1/2	867



Flame Cut Sprockets for Engineering Chains

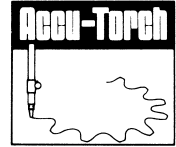

635 FLAME CUT SPROCKETS FOR CHAINS:

RO 635 — B 635 — X 635 — 1350 — 450 SX — 450 SXX — IS 4522 — 1340 RX — LXS 4522 M

Type C — 4.500" Pitch

PLATE THICKNESS 1³/₄"
ROLLER DIAMETER 2¹/₄"

Type A

Number of Teeth	Catalog Number	Pitch Diameter	Stock Bore	Max. Bore	Hub Diameter	L.T.B.	Approximate Weight	Catalog Number	Stock Bore	Approximate Weight
10	635C10	14.56	1½	4	6½	5	111	635A10	1½	87
12	635C12	17.39	1½	4	6½	5	148	635A12	1½	119
14	635C14	20.22	1½	4	6½	5	188	635A14	1½	159
30	635C30	43.05	1½	5%	7½	5%	592	635A30	1½	542
36	635C36	51.63	1½	5%	7½	5%	764	635A36	1½	715
42	635C42	60.22	1½	6%	9%	7%	884	635A42	1½	776
48	635C48	68.81	1½	7%	11	7%	1174	635A48	1½	963

1207 FLAME CUT SPROCKETS FOR CHAINS:

RX 1207 — RO 1205 — A 1302 — JS 5031 — 1510 XX — 1602 A — 1602 AA — US 5201 A — LXS 5028 — LXS 6038 M — MXS 5028

Type C — 5.000" Pitch

PLATE THICKNESS 2¹/₄"
ROLLER DIAMETER 2¹/₂"

Type A

Number of Teeth	Catalog Number	Pitch Diameter	Stock Bore	Max. Bore	Hub Diameter	L.T.B.	Approximate Weight	Catalog Number	Stock Bore	Approximate Weight
10	1207C10	16.18	1½	4½	6½	5½	160	1207A10	1½	131
12	1207C12	19.32	1½	4½	6½	5½	215	1207A12	1½	187
14	1207C14	22.47	1½	5%	7½	5%	298	1207A14	1½	254
30	1207C30	47.84	1½	6	9	6%	809	1207A30	1½	730
36	1207C36	57.37	1½	7	10	8½	1161	1207A36	1½	1025
42	1207C42	66.91	1½	7	10	8½	1245	1207A42	1½	1109
48	1207C48	76.45	1½	7½	11	10%	2005	1207A48	1½	1794

132 FLAME CUT SPROCKETS FOR CHAINS:

C 132 — A 132 — A 132 WS — WS 132 — C 132 M — C 132 W — SX 150 — SXA 150 — 150 X — 6150 — W 157 — WH 157 — WR 157

Type C — 6.050" Pitch

PLATE THICKNESS 2³/₄"
ROLLER DIAMETER 1²³/₃₂"

Type A

Number of Teeth	Catalog Number	Pitch Diameter	Stock Bore	Max. Bore	Hub Diameter	L.T.B.	Approximate Weight	Catalog Number	Stock Bore	Approximate Weight
6	132C6	12.10	1½	4½	6½	6	119	132A6	1½	90
7	132C7	13.95	1½	4½	6½	6	149	132A7	1½	120
8	132C8	15.81	1½	4½	6½	6	182	132A8	1½	153
9	132C9	17.69	1½	5%	7½	6%	236	132A9	1½	192
10	132C10	19.58	1½	5%	7½	6%	278	132A10	1½	235
11	132C11	21.47	1½	5%	7½	6%	326	132A11	1½	283
12	132C12	23.38	1½	5%	7½	6%	378	132A12	1½	334

ENGINEERED

Veneer Dryer Parts

81X 81 x (2.609) Hooked Tooth Sprocket "B" Style (Right and Left Hand)

No. Teeth	Part Number	Outside Diam.	Type	Bore		Hub (Inch)	
				Stock	Max.	Diam.	LTB
8	81X-B8RH	6 $\frac{1}{2}$	B	1	1 $\frac{1}{2}$	2 $\frac{1}{2}$	1 $\frac{1}{2}$
8	81X-B8LH	6 $\frac{1}{2}$	B	1	1 $\frac{1}{2}$	2 $\frac{1}{2}$	1 $\frac{1}{2}$

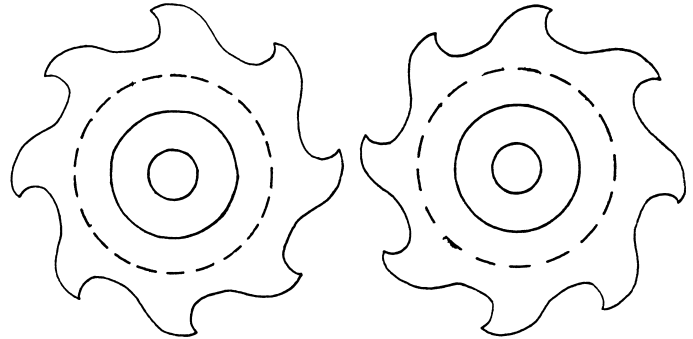

(RH) Right Hand

(LH) Left Hand

"C" Style

No. Teeth	Part Number	Outside Diam.	Type	Bore		Hub (Inch)	
				Stock	Max.	Diam.	LTB
7	81X-C7	5 $\frac{1}{4}$	C	$\frac{3}{4}$	1 $\frac{1}{2}$	2 $\frac{1}{2}$	2 $\frac{1}{8}$
8	81X-C8	6 $\frac{1}{4}$	C	$\frac{3}{4}$	1 $\frac{1}{2}$	2 $\frac{1}{2}$	2 $\frac{1}{8}$
9	81X-C9	7 $\frac{1}{16}$	C	$\frac{3}{4}$	1 $\frac{1}{2}$	2 $\frac{1}{2}$	2 $\frac{1}{8}$

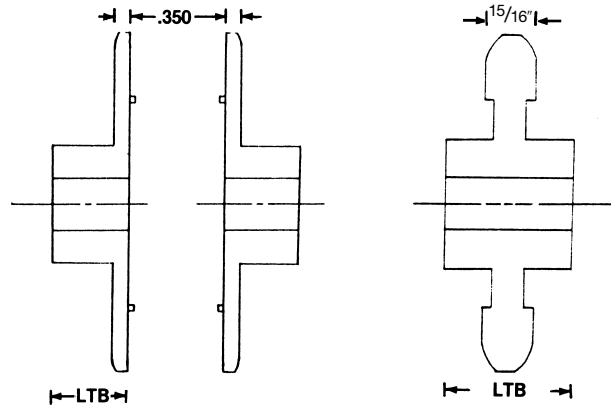

Type B
(Cast Iron)

Type C
(Cast Iron)



Star Gear

No. Teeth	Part Number	Outside Diam.	Type	Bore		Hub (Inch)	
				Stock	Max.	Diam.	LTB
10	SG510	4 $\frac{3}{16}$	B	1	1 $\frac{1}{2}$	2 $\frac{1}{2}$	2

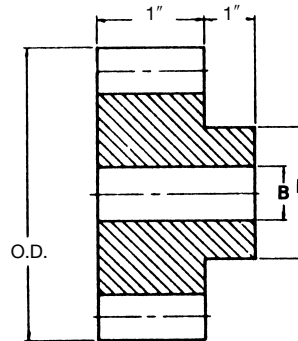

Type B
(Cast Iron)

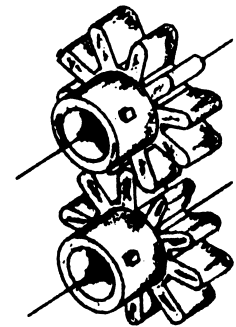

ENGINEERED